

# Sunbeam

Model # 9738

## Pioneer Fire Table

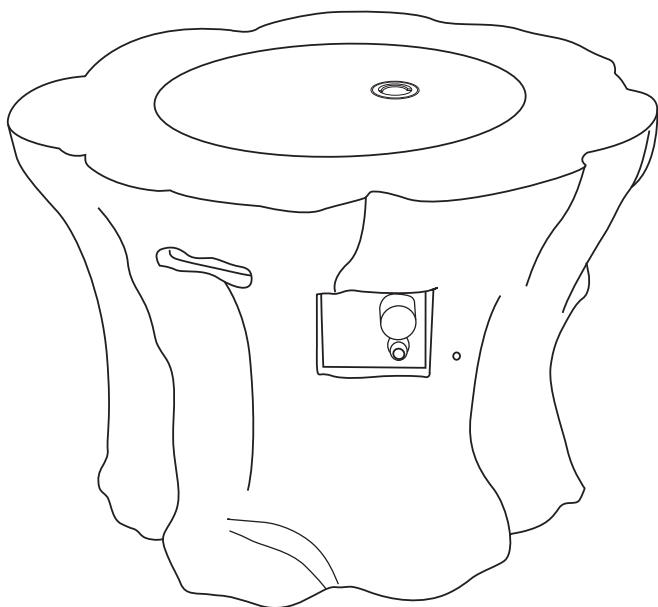

### **⚠ DANGER**

If you smell gas:

1. Shut off gas to the appliance.
2. Extinguish any open flame.
3. If odor continues, leave the area immediately.
4. After leaving the area, call your gas supplier or fire department.

Failure to follow these instructions could result in fire or explosion, which could cause property damage, personal injury or death.

### **⚠ WARNING**

Do not store or use gasoline or other flammable vapors and liquids in the vicinity of this or any other appliance. A propane cylinder not connected for use shall not be stored in the vicinity of this or any other appliance.

### **⚠ WARNING** For outdoor use only.

### **⚠ WARNING**

Improper installation, adjustment, alteration, service or maintenance can cause injury or property damage. Read the owner's manual thoroughly before installing or servicing this equipment. If the information in this manual is not followed exactly, a fire or explosion may result causing property damage, personal injury or loss of life.

Save these instructions for future use. If you are assembling this unit for someone else, give this manual to him or her and read and save for the future.



### **⚠ DANGER**



#### **CARBON MONOXIDE HAZARD**

This appliance can produce carbon monoxide which has no odor.

Using it in an enclosed space can kill you.

Never use this appliance in an enclosed space such as a camper, tent, car or home.

## Owner's Manual

# Safety Information

Before you assemble or operate this unit, please carefully read this entire manual. Failure to do so may result in a fire, explosion, injury or death.

## **WARNING**

- The installation of this unit must adhere to local codes or either the National Fuel Gas Code, ANSI Z21.97-2017/ CSA2.41-2017 Standard for Outdoor Decorative Gas Appliances.
  - **THIS UNIT IS INTENDED FOR OUTDOOR USE ONLY!** This product shall be used outdoors, in a ventilated space and shall not be used in any enclosed area.
  - This unit is to be used with propane gas only! (sold separately)
  - Do not attach a remote gas supply to this unit.
  - Only use propane gas for this unit.
  - This unit is not intended for natural gas.
  - Converting this unit to natural gas is dangerous and not recommended. The conversion of this unit will void the manufacturer warranty.
  - Do not use any solid fuel or charcoal for this unit.
  - When igniting this unit, stay away from the burner as the flame will light up and may cause injury.
  - **PROPANE GAS WARNING:** Do not use any more than 1/4 in. depth Flame Glass above the burner holes. Doing so will suffocate the flame.
  - If the propane gas tank is leaking gas, you may hear, see, or smell a hiss. Do the following:
    1. Disconnect the propane gas tank.
    2. Do not attempt to fix the problem yourself.
    3. Contact your gas supplier or fire department for help.
  - Applying too much propane may result in gas pooling and will not burn. Allow fresh air into the unit so that the remaining gas may escape.
  - Do not use a flame to check for gas leaks.
  - The maximum inlet supply pressure: maximum Gas supply 11 in. w.c. (2.74kPa)
  - Use propane tanks with the following dimensions: diameter 12 in., height 18 in. - capacity 20 lbs.
  - You must use a propane tank that has a collar to protect the gas valve.
  - **DO NOT** fill tank over 80 percent full.
  - The tank system must be set up for vapor withdrawal.
  - Discontinue use if any part of the propane tank is damaged. Rust and dents may be hazardous and should be inspected by a gas supplier.
  - Do not burn anything other than the provided materials for this fire table.
  - Always ensure that Flame Glass is completely dry before use. Failure to do so may cause them to crack or break.
  - Do not operate unit until all parts are fully assembled.
  - Do not paint or color any part of this fire pit.
  - Unit may be hot while in use, do not attempt to move it while in use.
  - Never leave this fire pit unattended while in use.
  - This unit is not intended for cooking.
  - Keep any flammable items away and do not use any other fireplace cover for this unit.
  - Keep a safe distance to avoid burning skin or clothing.
  - Do not sit or rest hands or feet on this fire pit.
  - Never place hands or fingers on upper portion of this unit while in use.
  - Keep all electrical cords and fuel supply hose away from heated surfaces.
  - Combustible material should not be within 72 in. of the top of the unit, or within 48 in. around the entire unit.
  - Keep the appliance area clear and free from combustible material, gasoline and other flammable vapors and liquids.
  - If the flame goes out while burning, turn the gas valve off. Wait 5 minutes before repeating the initial lighting procedure.
- Once you have a flame started, hold down the control knob for 1 minute.
- Do not add water into the unit.
  - Do not operate unit if any part has been under water. Immediately call a qualified service technician to inspect the appliance and replace any part of the control system and any gas control that has been under water.
  - Do not disconnect any part while unit is in use.
  - Do not store a spare propane tank on or near this unit.
  - If the fire pit is indoors, detach the propane tank and leave outdoors.
  - Do not operate on a boat or vehicle. This unit must be used on a flat surface and outdoors **ONLY**.

# Safety Information

- Always remove protective cover before operating (if applicable).
- Do not set the protective cover over the unit until it is turned off and completely cooled down.
- Check for leaks after not using the unit for long periods of time.
- Children should never operate this unit. Children must be supervised while near this unit.
- Keep gas tank at least 5 feet away from unit when lit. (if external tank)
- The maximum gas supply pressure is 250 psi.
- All installation and repair should be done by a qualified professional. This unit should be inspected annually and cleaned regularly.
- Inspect all elements of this fire pit before each use. If there is damage, the burner must be replaced.
- Keep the hose out from any pathways to eliminate any accidental damage. (if external tank)
- Be aware of the hazards of high temperatures and stay away from the unit to avoid any burns or injury.
- The gas supply tank should be constructed and marked with the specifications for the propane gas tanks of the U.S. Department of Transportation or the National Standard of Canada CAN/CSA-B339, propane gas tanks, spheres and tubes for Transportation of Dangerous Goods; and Commission.
- The propane gas tank must have a listed overfilling prevention device and a QCCI or Type I, (CGA810) propane gas tank connection.
- This heating appliance should not be used on plastic or artificial wood decks.
- Children and adults should be alerted to the hazards of high surface temperatures and should stay away to avoid burns or clothing ignition.
- Young children should be carefully supervised when they are in the area of the appliance.
- Clothing or other flammable materials should not be hung from the appliance or placed on or near the appliance.
- Any guard or other protective device removed for servicing the appliance shall be replaced prior to operating the appliance.
- Installation and repair should be done by a qualified service person. The appliance should be inspected before use and at least annually by a qualified service person. More frequent cleaning may be required as necessary. It is imperative that the control compartment, burners and circulating airways of the appliance are kept clean.

## IF APPLICABLE:

- Allow heating item to cool completely before placing on lid.
  - DO NOT use heating item while lid is installed. Always remove the lid while heating item is in use. Only use the regulator and hose assembly provided with this unit. Replacement parts must be supplied directly by Jay Trends. Inspect the burner before use of this unit. If the burner shows any kind of damage, do not operate the appliance. For assistance with repair or replacement of the burner or any other parts, call Jay Trends at 1-877-387-3639.
- NOTE: You must follow all steps to properly assemble this heating item. Make sure the gas valve is turned "OFF" before assembling. Do NOT attempt to assemble without proper tools.

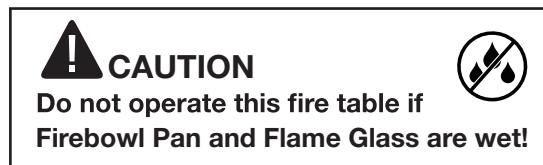
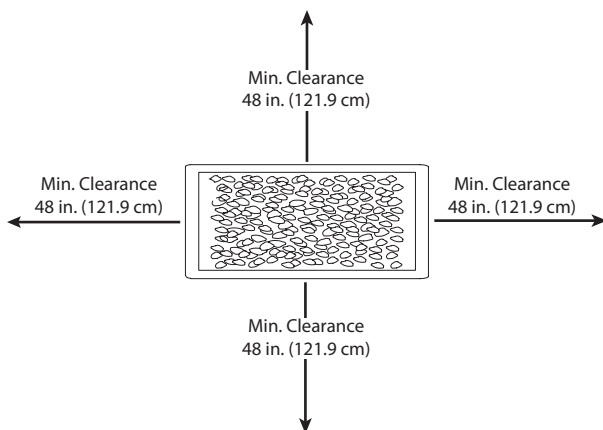

Combustible materials should not be within 72 in. of the top of the unit, or within 48 in. around the entire unit.

# Package Contents



PART	DESCRIPTION	QUANTITY
A	Flame Glass (23.1 lbs.)	2 Boxes
B	Protective Cover	1
C	Door	1
D	Body	1
E	Pre-assembled Feet	4
F	Lid	1

# Hardware Contents

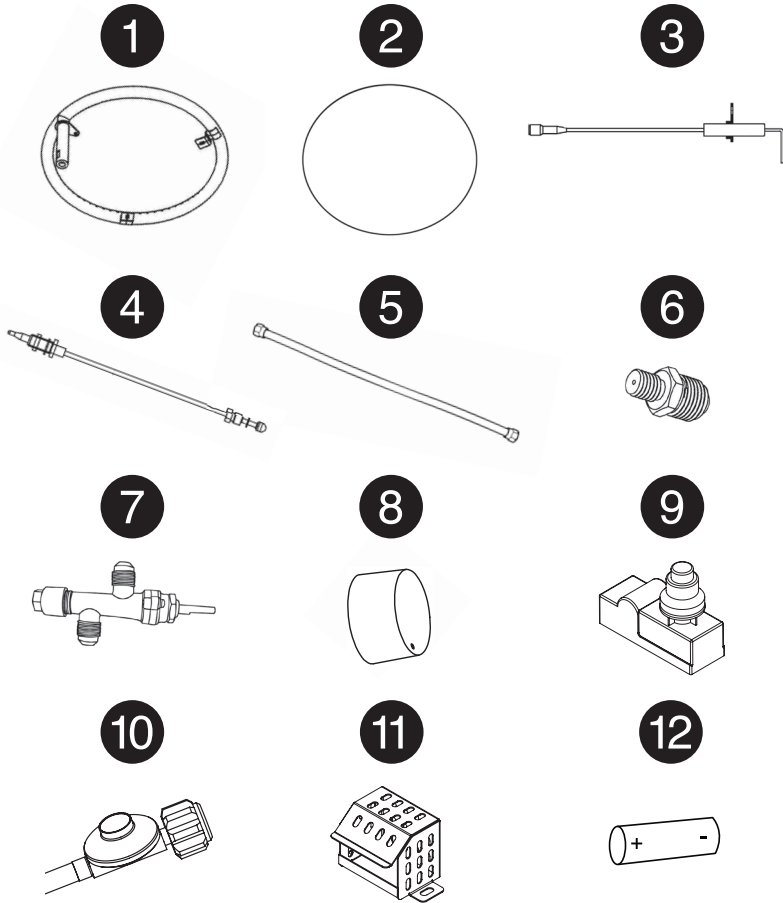

ITEM	DESCRIPTION	QTY
1	Burner	1
2	Firebowl Pan	1
3	Ignition Pin	1
4	Thermocouple	1
5	Corrugated Pipe	1
6	Propane Injector	1
7	Gas Valve	1
8	Control Knob	1
9	Pulse Ignition	1
10	Regulator	1
11	Ignition Screen	1
12	AAA Battery	1

## SAFETY INFORMATION

Please read and understand this entire manual before attempting to assemble, operate or install this appliance. If you have any questions regarding the product, please call customer service 1-877-387-3639, 8 a.m. – 4 p.m., EST, Monday – Friday. This appliance has been tested to and complies with the ANSI Z21.97-2017/CSA2.41-2017 Standard for Outdoor Decorative Gas Appliances. The installation must conform to local codes or in the absence of local codes, to the National Fuel Gas Code. ANSI Z21.97-2017/CSA2.41-2017. This manual contains important information about the assembly, operation and maintenance of this fire pit. General safety information is presented in the first few pages and is also located throughout this manual. Keep this manual for future reference and to educate new users of this appliance. This manual should be read in conjunction with the labeling on the appliance. Safety precautions are essential when any mechanical or propane fueled equipment is involved. These precautions are necessary when using, storing, and servicing. Using this appliance with the respect and caution demanded will reduce the possibilities of personal injury or property damage. The following symbols shown below are used extensively throughout this manual. Always heed these precautions, as they are essential when using any mechanical or propane fueled equipment.



### DANGER

DANGER indicates an imminently hazardous situation which, if not avoided, will result in death or serious injury.



### DANGER

Failure to comply with the precautions and instructions provided with this fire pit can result in death, serious bodily injury and property loss or damage from hazards of fire, explosion, burn asphyxiation, and/or carbon monoxide poisoning. Only persons who can understand and follow the instructions should use or service this fire pit.



### DANGER

FOR YOUR SAFETY:

If you smell gas:

1. Shut off gas to the appliance.
2. Extinguish any open flame.
3. If odor continues, keep away from the appliance and immediately call your gas supplier or fire department.



### CAUTION

Do not operate this fire table if  
Firebowl Pan and Flame Glass are wet!



# Assembly

## 1. Set Up

(I) Check each part before using the product. Make sure the gas supply system is turned "OFF" before assembling. See Figure A.

(II) Open the storage door on the firebowl for the gas tank. Take away the boxes containing the flame glass. See Figure A.

(III) Put the gas tank in the metal stand. Make sure the gas tank sits on the metal stand completely. Turn the wing screw on the outer part of metal stand clockwise to secure the gas tank. See Figure B.

(IV) Evenly distribute the flame glass in the firebowl. See Figure C.

**DO NOT COVER THE IGNITION SCREEN when placing the flame glass into the firebowl. Always keep ignition screen visible.**

The propane gas and cylinder are sold separately. Use a standard 20 lb. propane cylinder only. Use this fire pit only with a vapor withdrawal supply system. See Chapter 3 of the standard for storage and handling of liquefied petroleum gas, ANSA/NFPA 58. Your local library or fire department should have this book.

Storage of an appliance indoors is permissible only if the cylinder is disconnected and removed from the appliance. A cylinder must be stored outdoors in a well-ventilated area out of reach of children. A disconnected cylinder must have all dust caps tightly installed and must not be stored in a building, garage or any other enclosed area. The maximum inlet gas supply pressure: 250 psi. The minimum inlet gas supply pressure: 5 psi. The minimum hourly rate of 10,000 BTUs is required input rating for a fire pit for automatic operation at rating less than full input rating.

The pressure regulator and hose supplied with the appliance must be used. The installation must conform with local codes or in the absence of local codes, with national fuel gas code, ANSI Z21.97-2017/CSA2.41-2017, natural gas and propane Installation Code, CSA B1491.1, or propane storage and handling code, B149.2.

A dented, rusted or damaged propane cylinder may be hazardous and should be checked by your cylinder supplier. Never use a propane cylinder with a damaged valve connection.

The propane cylinder must be constructed and marked in accordance with the specifications for propane gas cylinders of the U.S. Department of Transportation (DOT) or the standard for cylinders, spheres and tubes for transportation of dangerous goods and commission, CAN/CSA-B339.

The cylinder must have a listed overfilling prevention device.

The cylinder must have a connection device compatible with the connection for the appliance.

The cylinder used must include a collar to protect the cylinder valve.

Never connect an unregulated propane cylinder to the appliance.

## 2. Connect Gas Tank

(I) Connect hose and regulator to cylinder. See Figure A.

(II) Turn the cylinder valve clockwise to close the gas supply on the gas cylinder. Screw the regulator coupling clockwise by hand only. Make sure it is fastened. See Figure B.

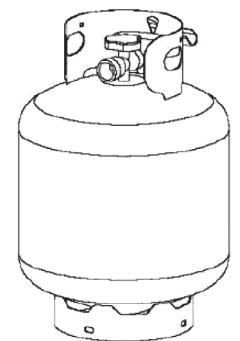
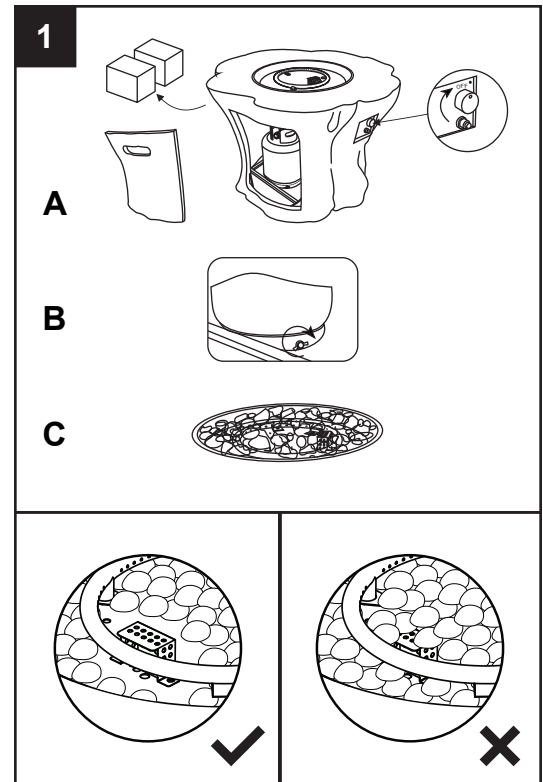

Standard 20 lb. tank

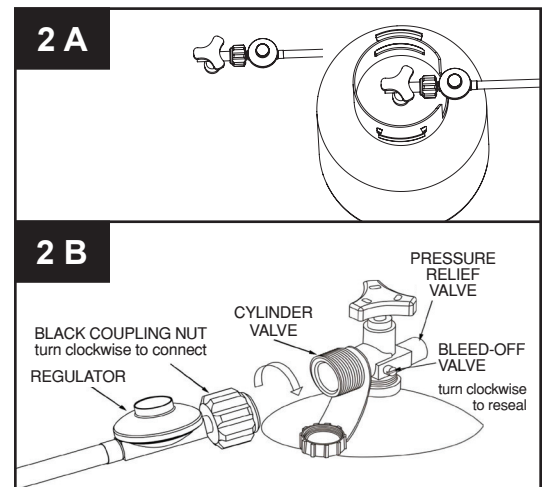



# Assembly

## 9. Perform Leak Test



### WARNING

Perform all tests outdoors.  
Extinguish all open flames.  
NEVER leak test when smoking.  
Do not use the fire table until all connections have been leak tested and do not leak.

- (I) Make 2-3 oz. of leak test solution (one part liquid dishwashing detergent and three parts water).
- (II) Make sure all fire table and light valves are OFF.
- (III) Apply several drops of solution where hose attaches to regulator.
- (IV) Apply several drops of solution where regulator connects to cylinder.
- (V) Turn cylinder valve ON.

**If bubbles appear at any connection, there is a leak.**

- (I) Turn cylinder valve OFF.
- (II) If leak is at hose/regulator connection: tighten connection and perform another leak test. If bubbles continue appearing, the hose should be returned to the place of purchase.
- (III) If leak is at regulator/cylinder valve connection: disconnect, reconnect, and perform another leak test. If you continue to see bubbles after several attempts, cylinder valve is defective and should be returned to cylinder place of purchase.

**If NO bubbles appear at any connection, the connections are secure.**

**NOTE:** Whenever gas connections are loosened or removed, you must perform a complete leak test.

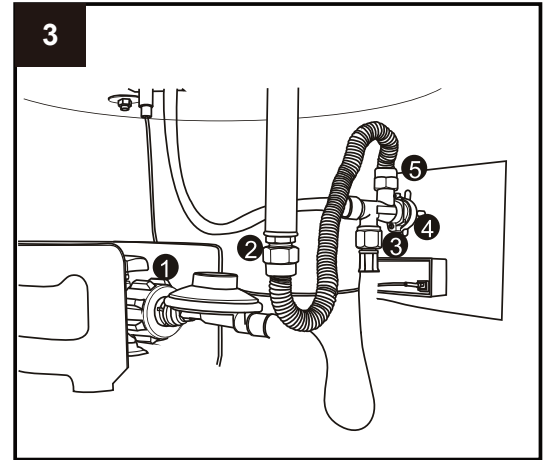

## 4. Install Battery to Electronic Igniter

- (I) Remove the rubber cap on the electronic igniter (A) by unscrewing and slide battery (B) into the battery slot. Make sure the positive side of the battery faces outwards. Screw the electronic igniter cap (A) over the battery tightly.

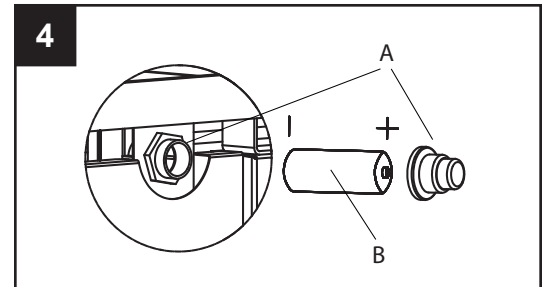

- Do not store a spare propane gas cylinder under or near this appliance.
- Never fill the cylinder beyond 80 percent full.
- Place the dust cap on the cylinder valve outlet whenever the cylinder is not in use. Only install the type of dust cap on the cylinder valve that is provided with the cylinder valve. Other type of caps or plugs may result in leakage of propane.



### CAUTION

Do not operate this fire table if  
Firebowl Pan and Flame Glass are wet!



# Operation

Do not sit or stand on this fire pit table.

Keep children away during assembly, as this item contains small parts which can be swallowed by children.

Do not use indoors or inside any enclosure.

Retain the assembly instructions for future reference.

Installer – Please leave these instructions with the owner.

For a safe heating experience, perform these checks before each use.

## Before Operating:

1. Familiarize yourself with owner's manual to understand all precautions.
2. All components are properly assembled, intact and operable.
3. No alterations have been made.
4. All gas connections are secure and do not leak.
5. Do not operate if wind is 10 mph or above.
6. Unit will operate at reduced efficiency below 40°F/4°C.
7. Fire pit is outdoors (outside any enclosure).
8. There is adequate fresh air ventilation. Do not use this appliance if any part has been under water. Immediately call a qualified service technician to inspect the appliance and to replace any part of the control system and gas control which has been under water.
9. Fire pit is away from gasoline or other flammable liquids or vapors.
10. Fire pit is away from windows, air intake openings, sprinklers and other water sources.
11. Fire pit is at least 24 in. on rear and sides from combustible materials and 72 in. from ceiling.
12. Fire pit is on a hard and level surface.
13. There are no signs of spiders or insects.
14. All burner passages are clear.
15. All air circulation passages are clear.
16. Children and adults should be alerted to the hazards of high surface temperature and should stay away to avoid burns or clothing ignition.
17. Young children should be carefully supervised when they are in the area of the fire pit.
18. Clothing or other protective material should not be hung from the fire pit, or placed on or near the fire pit.
19. Any guard or other protective device removed for servicing the fire pit must be replaced prior to operating the fire pit.
20. Installation and repair should be done by a qualified service person. The fire pit should be inspected before use and at least annually by a qualified service person.
21. More frequent cleaning may be required as necessary. It is imperative that control compartment, burner and circulating air passageways of the fire pit be kept clean.

## After Operation:

1. Gas control is in OFF position.
2. Gas tank valve is OFF.
3. Gas line has been disconnected.
4. After each use, replace cap on gas tank.



### CAUTION

Do not operate this fire table if Firebowl Pan and Flame Glass are wet!



### DANGER CARBON MONOXIDE HAZARD

For outdoor use only. Never use inside house, or other unventilated or enclosed areas. This fire pit consumes air (oxygen). Do not use in an unventilated or enclosed areas to avoid endangering your life.



### WARNING VERY HOT WHILE IN OPERATION

Never lean over the fire pit while in use. Do not touch surfaces while the fire pit is in operation. Wait until the fire pit has completely cooled down after use. Failure to comply with these instructions may result in serious bodily injury.



# Operation

**Caution:** Do not attempt to operate until you have read and understand all Safety Information in this manual and all assembly is complete and leak checks have been performed.

## Before Turning Gas Supply On:

1. Your fire pit was designed and approved for outdoor use only. Do NOT use it inside a building, garage, or any other enclosed area.
2. Make sure surrounding areas are free of combustible materials, gasoline, and other flammable vapors or liquids.
3. Ensure that there is no obstruction to air ventilation. Be sure all gas connections are tight and there are no leaks.
4. Be sure the cylinder cover is clear of debris. Be sure any component removed during assembly or servicing is replaced and fastened prior to starting.

## Before Lighting:

1. Fire pit should be thoroughly inspected before each use, and by a qualified service person at least annually. If relighting a hot fire pit, always wait at least 5 minutes.
2. Inspect the hose assembly for evidence of excessive abrasion, cuts, or wear. Suspected areas should be leak tested. If the hose leaks, it must be replaced prior to operation. Only use the replacement hose assembly specified by manufacturer. The burner must be replaced prior to the appliance being put into operation if it is evident that the burner is damaged. The replacement burner should be specified by manufacturer.

## Lighting:

1. Make sure the control knob is in the “OFF” position (Figure A).
2. Fully open propane cylinder valve.

**Note:** For initial start or after any cylinder change, hold Control Knob IN for 2 minutes to purge air from gas lines before proceeding.

3. Push in gas control knob, turn counterclockwise to “LOW” (Figure B), and press the BLACK ignitor button to light the fire pit. If needed, keep the control knob depressed and continue pressing the BLACK ignitor button until the fire pit lights (you should hear a clicking sound).
4. After the fire pit lights, release control knob. To increase the flame, turn the control knob counterclockwise to “HIGH” (Figure C). To decrease the flame, turn the control knob clockwise to “LOW”.

**Note:** If burner fails to remain lit, all valves should be closed and a waiting period of at least 5 minutes should pass before attempting to light.

Figure A

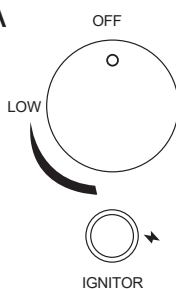

Figure B

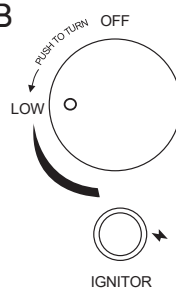
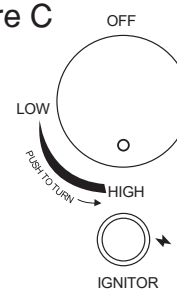

Figure C



### WARNING FOR YOUR SAFETY

Be careful when attempting to manually ignite this fire pit. Holding in the control knob for more than 10 seconds before igniting the gas will cause a ball of flame upon ignition.

### Re-lighting:

1. Turn control knob to “OFF”.
2. Repeat the “Lighting” steps on prior page.



### WARNING FOR YOUR SAFETY

Fire pit will be hot after use. Handle with extreme care.

### Turn off:

1. To extinguish burner depress control knob and continue to turn it clockwise to “OFF”.
2. Turn cylinder valve clockwise to “OFF” and disconnect regulator when fire pit is not in use.

# Care & Maintenance

To enjoy years of performance from your fire pit, make sure you perform the following maintenance activities on a regular basis:



## WARNING FOR YOUR SAFETY

**Do not touch or move fire pit for at least 45 minutes after use. Fire pit is hot to the touch. Allow fire pit to cool completely before using lid and protective cover.**

### Keep exterior surfaces clean.

1. Use warm soapy water for cleaning. Never use flammable or corrosive cleaning agents.
2. While cleaning your unit, be sure to keep the area around the burner dry at all times. Do not submerge the control valve assembly. If the gas control is submerged in water, do NOT use it. It must be replaced.

- Keep the appliance area clear and free from combustible materials, gasoline and other flammable vapors and liquids.
- Do not obstruct the flow of combustion and ventilation air.
- Keep the ventilation opening of the cylinder enclosure free and clear from debris.

3. Air flow must be unobstructed. Keep controls, burner, and circulating air passageways clean. Signs of possible blockage include:

- Gas odor with extreme yellow tipping of flame.
- Fire pit does NOT reach the desired temperature.
- Fire pit glow is excessively uneven.
- Fire pit makes popping noises.
- Spiders and insects can nest in burner or orifices. This dangerous condition can damage fire pit and render it unsafe for use. Clean burner holes by using a heavy-duty pipe cleaner. Compressed air may help clear away smaller particles.
- Carbon deposits may create a fire hazard. Clean burner with warm soapy water if any carbon deposits develop.

**Note:** In a salt-air environment (such as near an ocean), corrosion occurs more quickly than normal. Frequently check for corroded areas and repair them promptly.

### Storage

Between uses:

- Turn Control Knob OFF.
- Disconnect propane source.
- Store fire pit in an area sheltered from direct contact with inclement weather (such as rain, sleet, hail, snow, dust and debris).
- If desired, cover fire pit to protect exterior surfaces and to help prevent build-up in air passages.

**Note:** Wait until fire pit is cool before covering.

### During periods of extended inactivity or when transporting:

- Turn Control Knob OFF.
- Disconnect propane source and move to a secure, well-ventilated location outdoors.
- Store fire pit in an area sheltered from direct contact with inclement weather (such as rain, sleet, hail, snow, dust and debris).
- If desired, cover fire pit to protect exterior surfaces and to help prevent build-up in air passages.
- Never leave propane cylinder exposed to direct sunlight or excessive heat.

**Note:** Wait until fire pit is cool before covering.

### Service

Only a qualified service person should repair gas passages and associated components.

### Troubleshooting

PROBLEM	POSSIBLE CAUSE	CORRECTIVE ACTION
Burner won't light	Propane cylinder is empty	Replace propane cylinder
	Blockage in orifice	Clear blockage
	Control knob is not in ON position	Turn control knob to ON
Burner flame is low	Gas pressure is low	Turn cylinder valve OFF and re-fill the cylinder
	Outdoor temperature is less than 40 °F	Use a full cylinder
	Control knob is fully on	Check burner and orifices for blockage
Carbon build-up	Dirt or film on burner	Clean burner
Thick black smoke	Blockage in burner	Remove blockage and clean burner inside & outside

# Limited Warranty

## JAY TRENDS SALES LIMITED ONE (1) YEAR WARRANTY

Jay Trends warrants your new outdoor fire table/ fire pit product will be free from defects in material and workmanship for one (1) year from the date of purchase.

### Conditions and Limitations

Jay Trends warrants its products against manufacturing defects to the original purchaser only, and is subject to the following conditions and limitations:

This factory warranty is non-transferable and may not be extended what-so-ever by any of our representatives.

The product must be assembled, maintained, and operated in accordance with the printed instructions accompanying it. This limited warranty does not cover damages caused by misuse, lack of maintenance, grease fires, hostile environments, accident, alterations, abuse or neglect and parts installed from other manufacturers will nullify this warranty. Discoloration from chemical cleaners or UV exposure is not covered by this warranty.

Any damages to the product due to weather damage, hail, rough handling, damaging chemicals or cleaners will not be the responsibility of Jay Trends.

This limited warranty does not cover any scratches, dents, painted finishes, corrosion or discoloring by heat, abrasive and chemical cleaners, nor chipping on porcelain enamel parts, nor any components used in the installation of the product.

Should deterioration of parts occur to the degree of non-performance (rusted through or burnt through) within the duration of the warranted coverage, a replacement part will be provided.

The bill of sale or copy will be required when making any warranty claims from Jay Trends.

All parts replaced under the Limited One (1) Year Warranty Policy are subject to a single claim.

Jay Trends will not be responsible for the installation, labor, or any other costs related to the re-installation of a warranted part, and such expenses are not covered by this warranty.

Jay Trends reserves the right to have its representative inspect any product or part prior to honoring any warranty claim.

Jay Trends shall not be liable for any transportation charges, labor costs, or export duties.

### Replacement Parts

In the event that an item was received missing parts or damaged, either by the manufacturer or in shipping, you may request a replacement part. Replacement parts are not available for all units and only given at Jay Trends' discretion. We will assess any damage and find a solution, which could include ordering and shipping a replacement to you. No replacements are available for discontinued items or repackaged (open box) products. Please call Jay Trends Customer Service at 1-877-387-3639 for replacement parts before returning the damaged item. Please have the following information, which can be found in your instruction manual, ready before you call Customer Service.

1. Model Number or Item # \_\_\_\_\_ .
2. Serial # \_\_\_\_\_ & Part # \_\_\_\_\_ .
3. Shipping Address \_\_\_\_\_ .
4. A picture of the damaged item/part/unit.
5. Pictures should be sent to [custserv@jaytrends.com](mailto:custserv@jaytrends.com).
6. Proof of purchase with date \_\_\_\_\_ .
7. All claims must be received within 30 days of receipt of order.

Jay Trends Sales  
1901 Aut. Transcanadienne  
Dorval, QC H9P 1J1, Canada  
[www.jaytrends.com](http://www.jaytrends.com)

Customer Service: 1-877-387-3639 in USA & Canada  
[custserv@jaytrends.com](mailto:custserv@jaytrends.com)